

525 SN

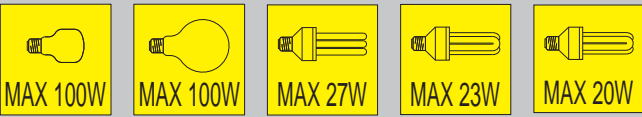

F E27 IP43 CL. I CE

525 DP

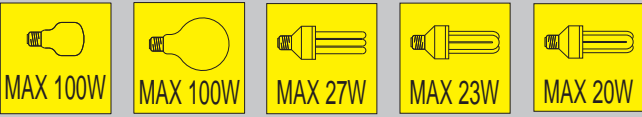

LAMPADE A INCANDESCENZA

LAMPADE FLUORESCENTI COMPATTE INTEGRATE

CORPO: ALLUMINIO  
BRACCI DISPONIBILI CON ANGIOLIERA  
PALI CORREDATI DI VITI INOX E TASSELLI  
PER FISSAGGIO A TERRA

GRADO DI PROTEZIONE GARANTITO DALLA  
PRESENZA DI UNA GUARNIZIONE AL SILICONE  
POSTA TRA LAMPADINA E PTL.

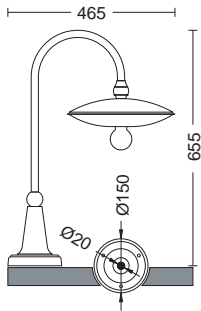

525 L DP

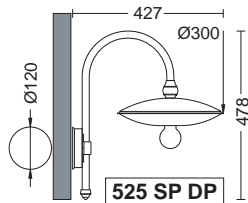

525 SP DP

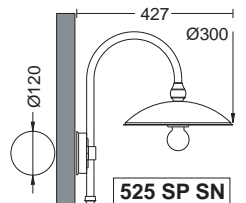

525 SP SN

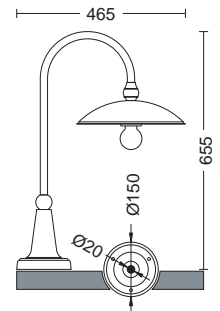

525 L SN

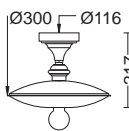

521 PL DP

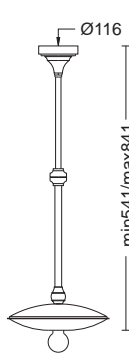

521 TS DP

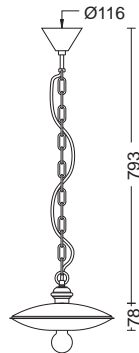

521 S DP

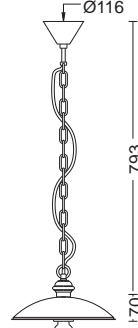

521 S SN

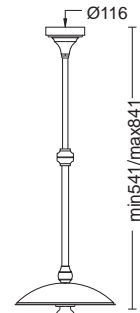

521 TS SN

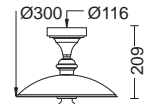

521 PL SN

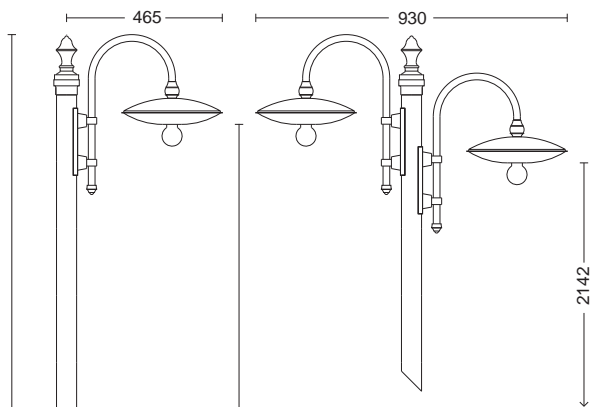

525/2 DP T/10

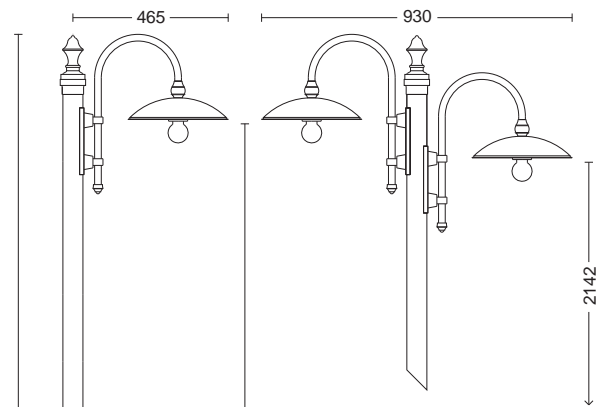

525/2 SN T/10

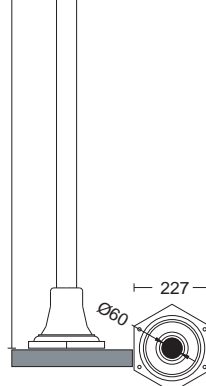

525/1 DP T/10

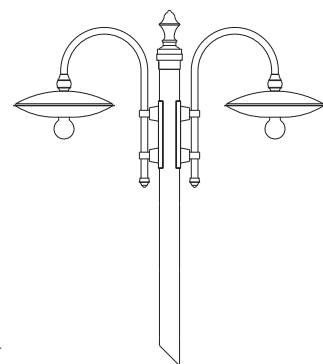

525/2 P DP T/10

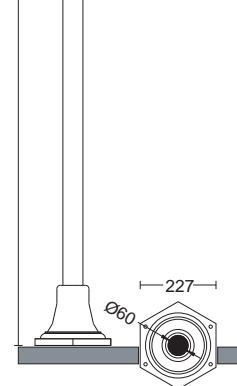

525/1 SN T/10

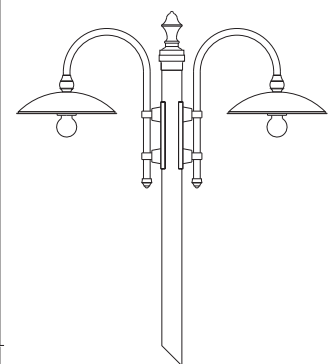

525/2 P SN T/10